



Your Sterilizer Experts

Manufacturing – Distribution – Maintenance- Guaranteed!

Alfa Medical
265 Post Ave
Westbury, NY 11590

1-800-762-1586
516-280-7822
516-280-7832 Fax
www.sterilizers.com
Email@sterilizers.com

The attached manual is for your records.
Go to the below web site to look for parts

<http://bit.ly/Pelton-OCR>

Alfa Medical * 265 Post Avenue, Westbury NY 11590
1-800-762-1586 Fax 516-977-7434
International Calls 516-280-7822

Pelton & Crane OCR Manual & Part List

MANUAL

For pelton And Crane Ocr 'AutoClave Sterilizer





Your Sterilizer Experts

Manufacturing - Distribution - Maintenance - Guaranteed!

Alfa Medical
265 Post Ave
Westbury, NY 11590

1-800-762-1586
516-280-7822
516-977-7434(Fax)
Website www.sterilizers.com
Email sterilizers.com

OCR Original Pelton Crane Manual

1. Place unit on a **leveled surface**. This will allow the chamber to fill with the right amount of water.
2. Fill reservoir 2 inches from top with distilled water.
3. Plug sterilizer into grounded outlet.
4. Put instruments on tray and into chamber.
5. While door open, turn bottom switch to '**fill**' position, and leave at that position for about 50 seconds, until water reaches the front rim of the chamber. Please be sure timer is set on zero. ***Note: Unit will not fill if timer is not on the off position*.**
6. Close door.
7. Make sure the middle knob is turned all the way clockwise. This will ensure 270f. By turning the middle knob counterclockwise...you will be reducing the temperature.
8. Turn timer to 15 minutes + appropriate time (look at table below).
Note: Timer will buzz for 20 seconds when turned on.
9. Turn the bottom switch to '**sterilize**' position.
10. Both red & orange light will come on.
11. At end of cycle, the timer and both orange & red lights will be turned off and the pressure will be vented automatically.
12. When pressure gauge shows '**zero**', you may open the door.
13. If you want the instruments to be dryer than they are...leave the door slightly open, and turn the bottom switch to vent position and set the timer to 10-15 minutes.

*** Important notice - Please do not attempt to adjust the front legs. They have been intentionally set this way*.**

General Guidelines*

| | | | | |
|----------------------------|------|------|-------|-------|
| Unwrapped instruments..... | 121c | 250f | 15psi | 15min |
| | 132c | 270f | 30psi | 3min |
| Lightly wrapped..... | 121c | 250f | 15psi | 20min |
| | 132c | 270f | 30psi | 9min |
| Heavily wrapped..... | 121c | 250f | 15psi | 25min |
| | 132c | 270f | 30psi | 11min |

- It is our recommendation that you consult your instrument manufacturer for accurate temperature & time schedule best suited for the instruments you are sterilizing.
- For the health & safety of your patients and staff, sterilizers must be biologically monitored to meet CDC, ADA and OSHA.
- Use Sterilizer Cleaner weekly (Alfa Clean p/n AME-AC16).

OCR, OCR⁺, & OCM Technical Data

Product Information:

Year Manufactured: OCR = 1961 - 1989, OCR⁺ = 1975 - 1988, OCM = 1961 - 1988

Serial Number Location: Rear Center of bottom plate.

Serial Number Prefix: OCR = A4, OCR⁺ = A8, OCM = A3

Unique Characteristics: All units have metal doors. The OCM and OCR doors latch on the left, while the OCR⁺ with two handles latches on the right. The most effective way to the unit model is by the serial number and the prefix.

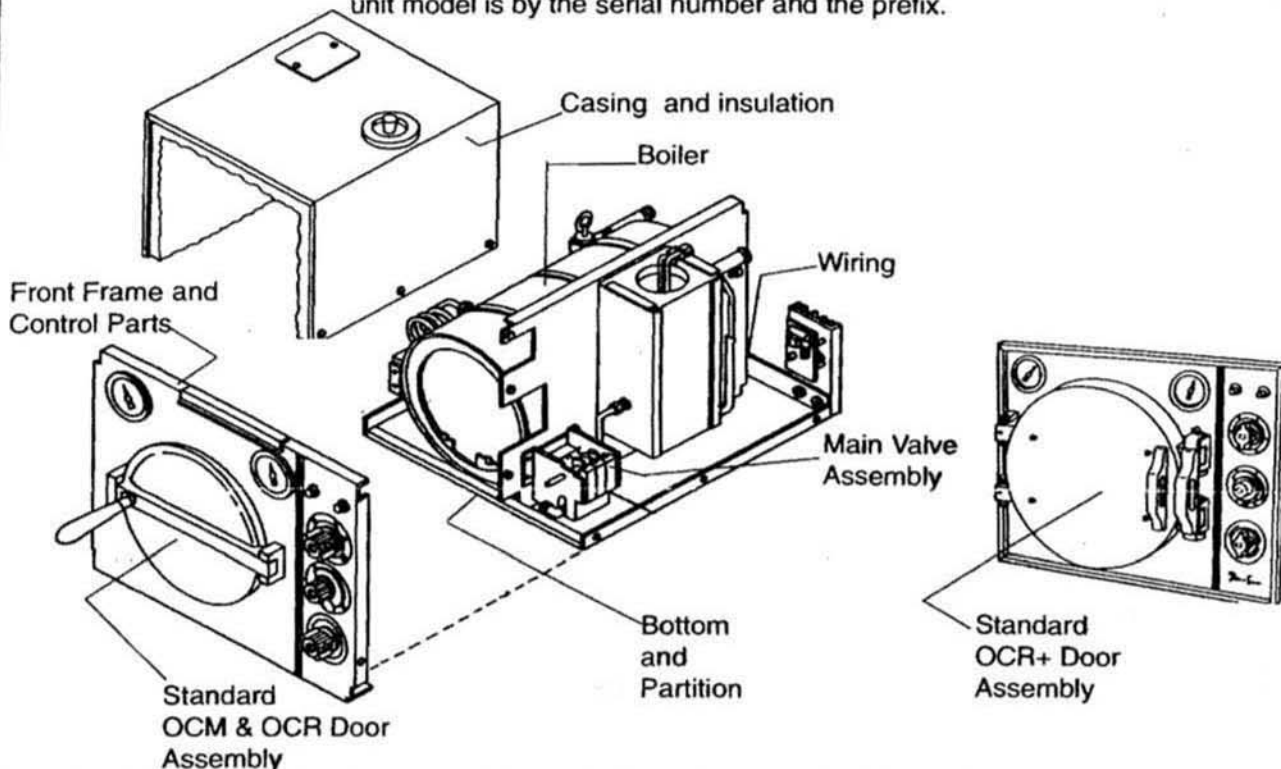

Trouble Shooting:

| Symptom | Cause | Solution |
|---|--|--|
| No "Heat On" light | <ol style="list-style-type: none"> 1. Heater element resistance not acceptable. 2. Thermistor resistance not acceptable. 3. Solid state controller not functioning. | <ol style="list-style-type: none"> 1. Replace heater element: OCR- 8 ohms M100371 2. Replace thermistor M100378 3. Replace solid state controller M100376 |
| Overheating | <ol style="list-style-type: none"> 1. Wire to ground or element grounded. 2. Solid State Controller defective. 3. Front pot defective. | <ol style="list-style-type: none"> 1. Check resistance of element. 2. Replace controller M100376 3. Replace front pot M100322 |
| Heat cuts off prematurely. | <ol style="list-style-type: none"> 1. Defective Thermistor. 2. Control pot on solid state board set to low. | <ol style="list-style-type: none"> 1. Replace Thermistor M100378 2. Adjust door switch rod. 3. Adjust control pot. |
| Water returns to chamber after VENTING. | <ol style="list-style-type: none"> 1. Main valve pin is sticking. 2. Crack in condenser coil. | <ol style="list-style-type: none"> 1. Lubricate pin. 2. Replace condenser coil, M100335 |

OCR+ Diagram

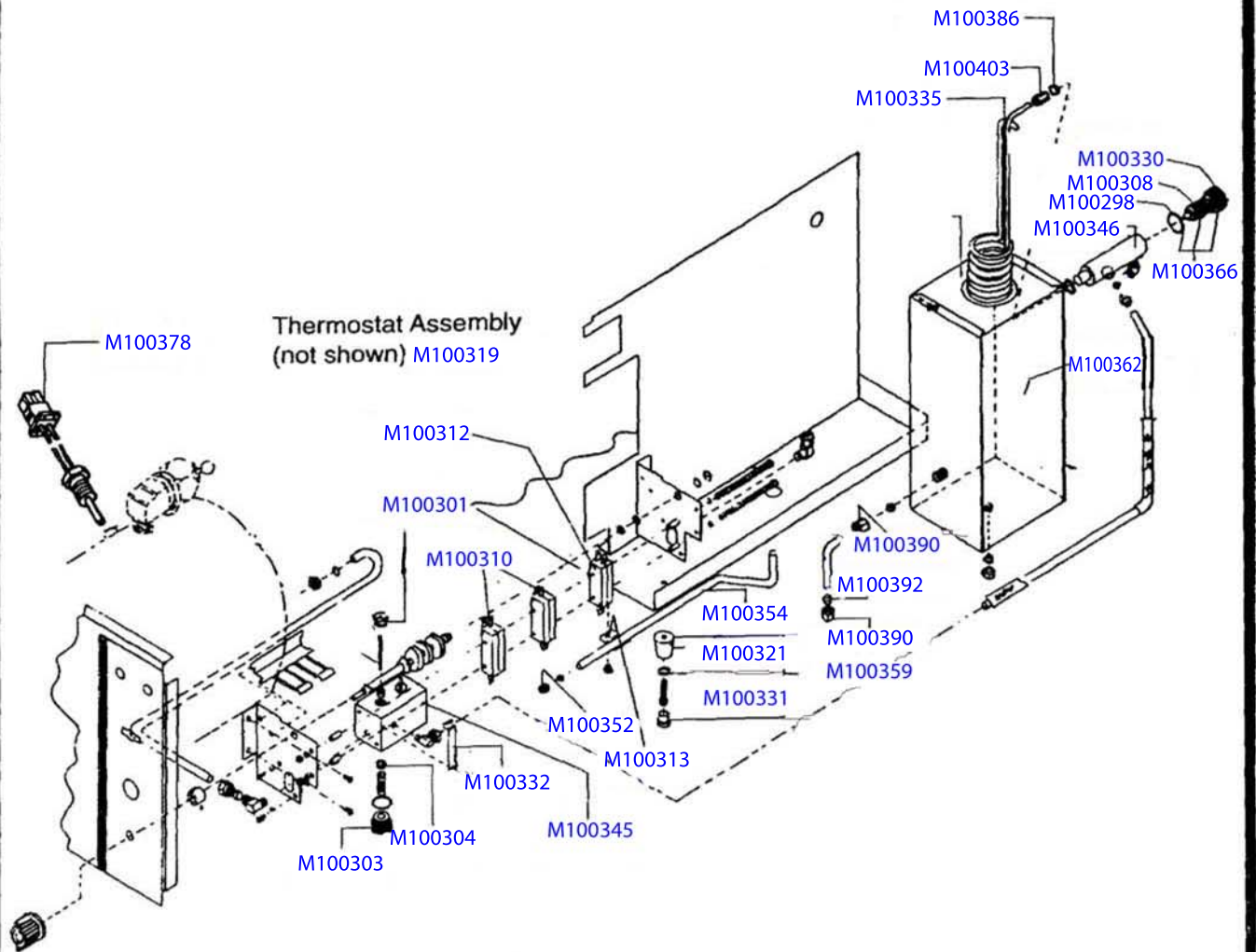
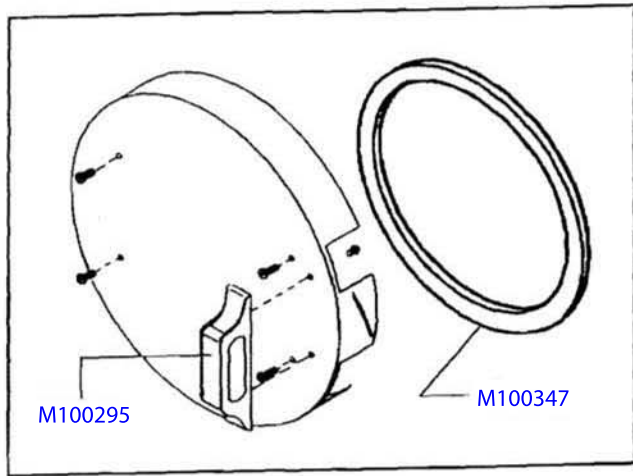

OCR+ Diagram

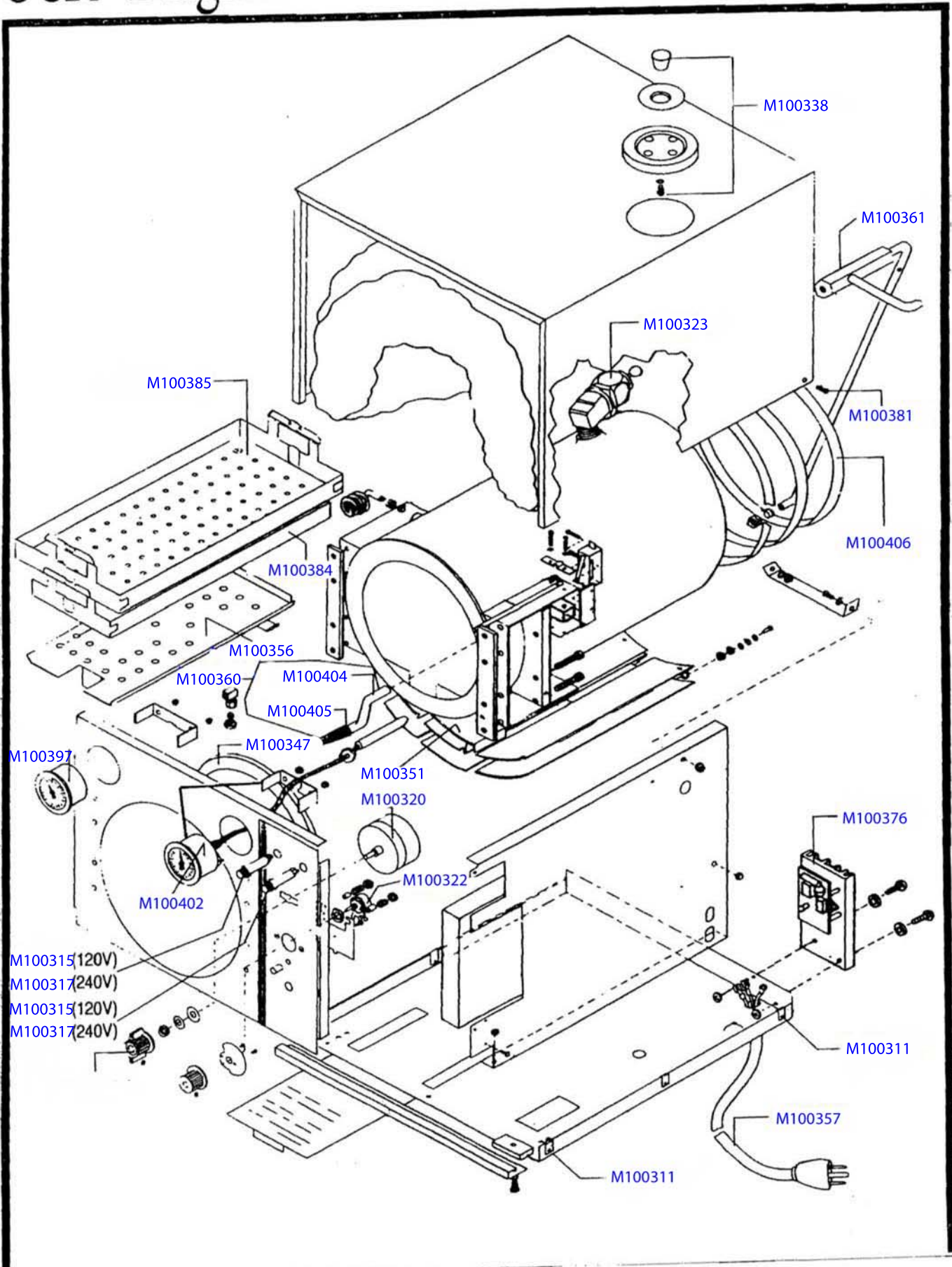

OCR & OCM FRONT FRAME & CONTROL PANEL DIAGRAM

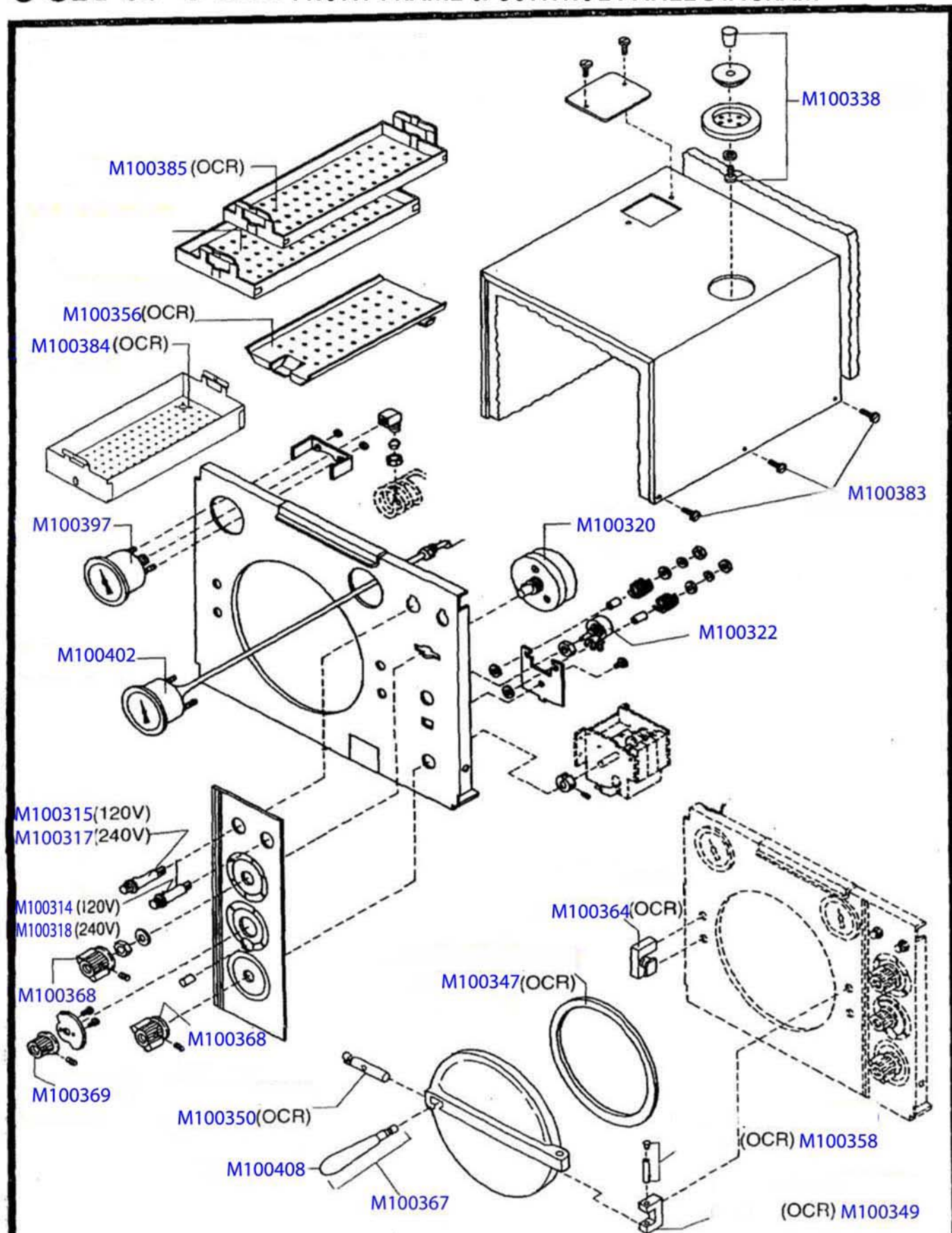



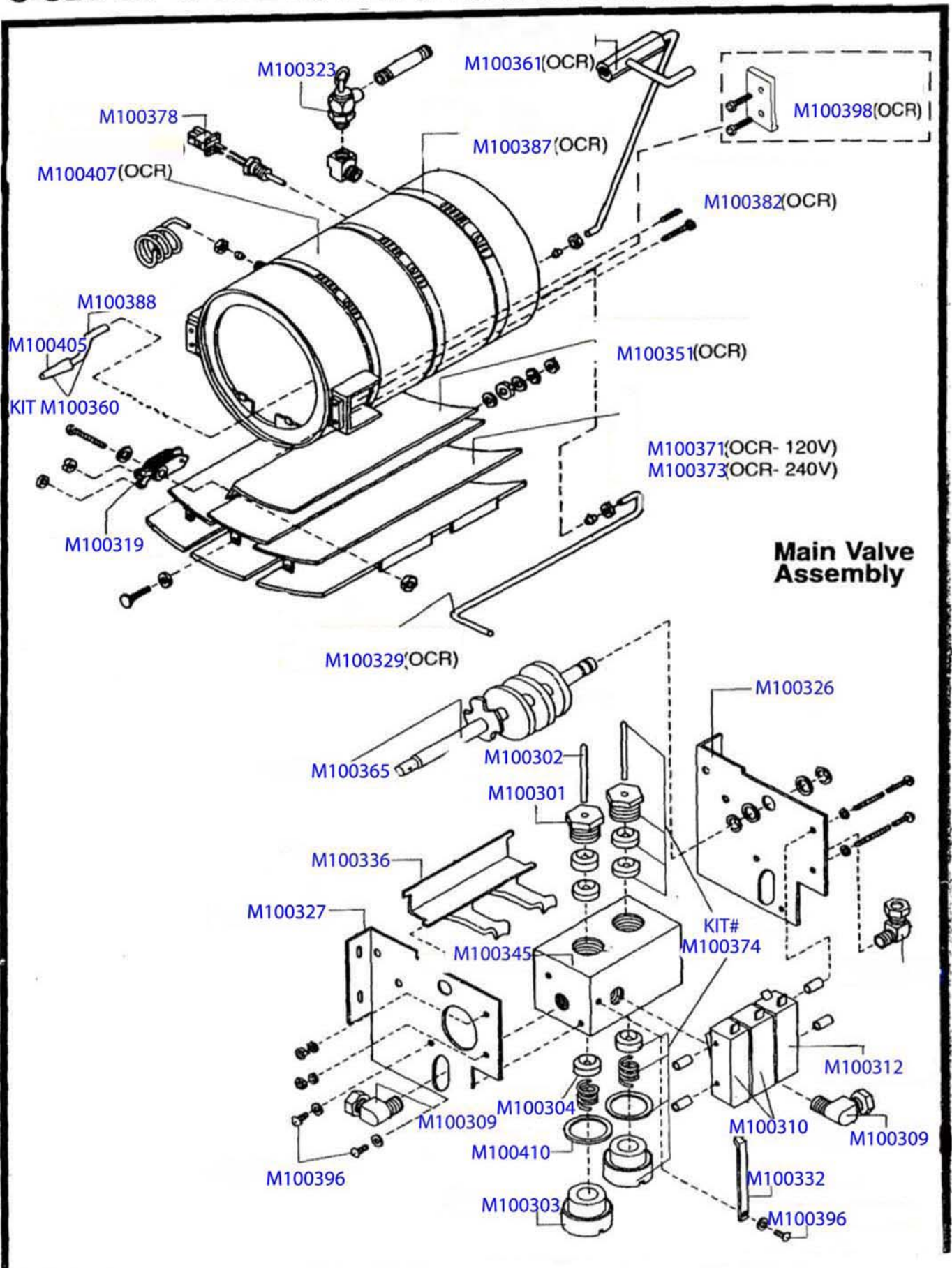



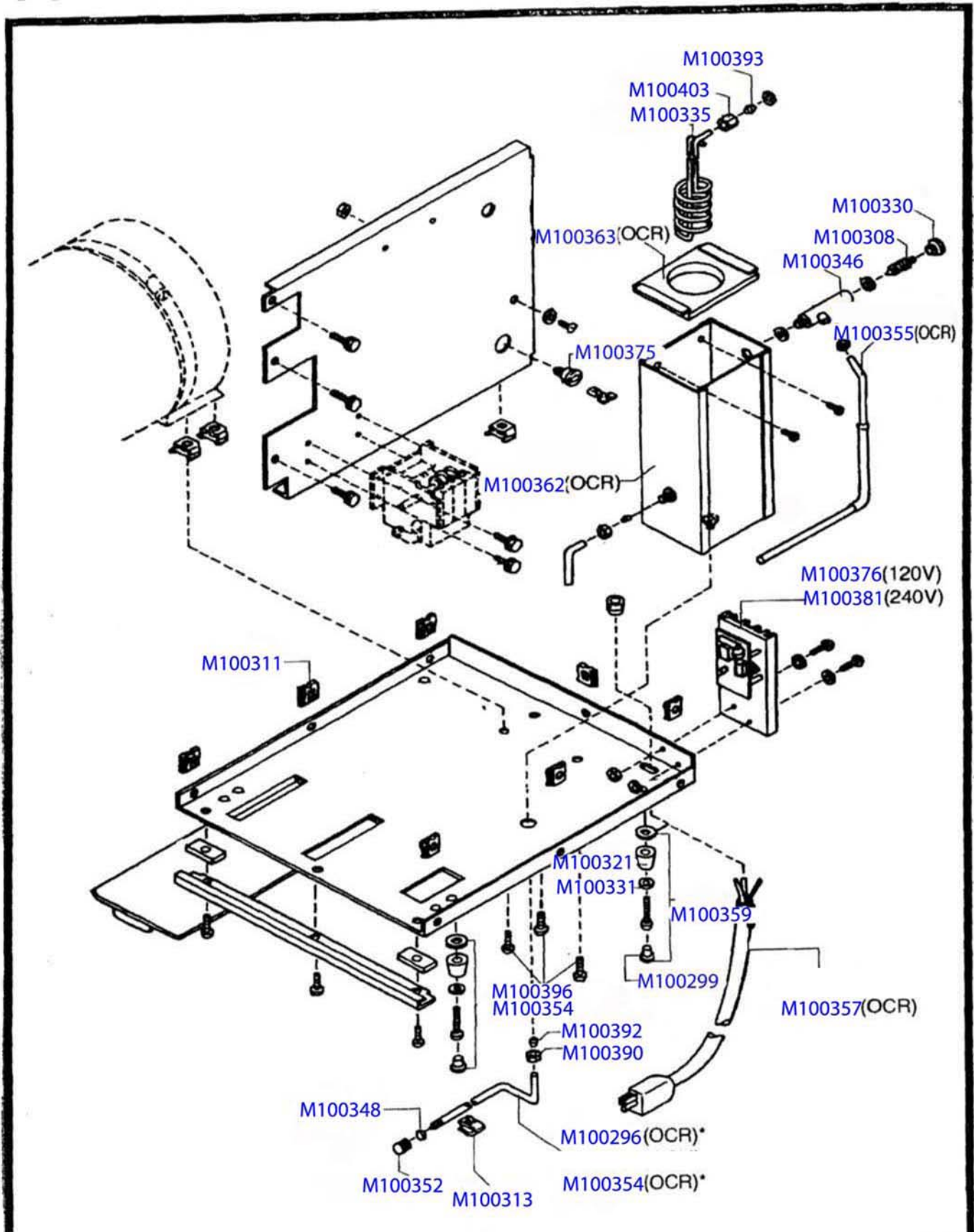

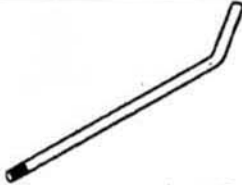
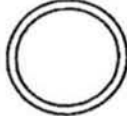
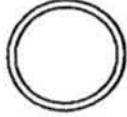



OCR & OCM BOILER & TUBING DIAGRAM





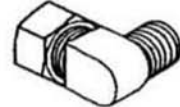
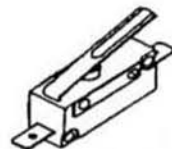

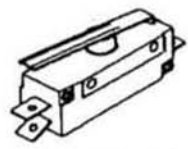

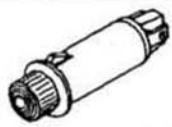







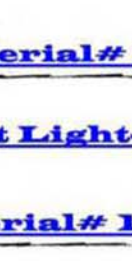



OCR & OCM BOTTOM & PARTITION DIAGRAM



| | Part No. | Description |
|---|----------|---|
|  | | <u>Door Handle</u> |
| | M100295 | (OCR+) |
|  | | <u>Drain Tube</u> |
| | M100296 | (OCR) (Serial #1001 to 5670) |
|  | | <u>Main Valve O-Ring</u> |
| | M100297 | (All Models) |
|  | | <u>Air Valve O-Ring</u> |
| | M100298 | (All Models) |
|  | | <u>Rubber Foot Insert</u> |
| | M100299 | (All Models) |
|  | | <u>Main Valve Stern</u> |
| | M100301 | (All Models) |
|  | | <u>Main Valve Stern</u> |
| | M100302 | (All Models) |
|  | | <u>Main Valve Cap</u> |
| | M100303 | (All Models) |
|  | | <u>Valve Button & Retainer</u> |
| | M100304 | (All Models) |

| | Part No. | Description |
|---|----------|--|
|  | M100307 | <u>Door Handle (OCR & OCM)</u> |
|  | M100308 | <u>Bellows (All Models)</u> |
|  | M100309 | <u>Male Elbow</u> |
|  | M100310 | <u>Power Switch-Two Lead (All Models)</u> |
|  | M100311 | <u>Speed Nut (All Models)</u> |
|  | M100312 | <u>Function Switch Three Lead</u> |
|  | M100313 | <u>Tube Clip (All Models)</u> |
|  | M1003014 | <u>Heat "ON" Light-120v (All Models)</u> |

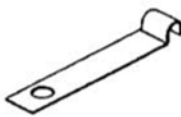
| | Part No. | Description |
|---|----------|---|
|  | M100315 | <u>Power "ON" Light (120v)</u> <u>(All Models)</u> |
|  | M100317 | <u>Power "ON" Light (240V)</u> <u>(Serial# 1001 & Above)</u> |
|  | M100318 | <u>Pilot Light- 240v</u> <u>Serial# 12228 & Above</u> |
|  | M100319 | <u>Overheat Thermostat</u> <u>(OCM & OCR)</u> |
|  | M100320 | <u>Bell Timer (All Models)</u> |
|  | M100321 | <u>Retainer Foot</u> <u>All Models</u> |
|  | M100322 | <u>Controller (All Models)</u> |
|  | M100323 | <u>Pressure Relief Valve</u> <u>All Models</u> |

| | Part No. | Description |
|---|----------|--|
|  | M100324 | <u>Door Cam (OCM)</u> |
|  | M100325 | <u>Door Hinge Block (OCM)</u> |
|  | M100326 | <u>Valve Bracket-Right (All Models)</u> |
|  | M100327 | <u>Valve Bracket-Left (All Models)</u> |
|  | M100328 | <u>Overheat Shield (OCM)</u> |
|  | M100329 | <u>Fill Tube (OCR)</u> |
|  | M100330 | <u>Bellows Cap (OCR)</u> |
|  | M100331 | <u>Leveling Washer (All Models)</u> |
|  | M100332 | <u>Locator Arm (all Models)</u> |
|  | M100333 | <u>Drain Tube (OCM)</u> |
|  | M100334 | <u>Air Valve Tube/Main Valve (OCM)</u> |

| | Part No. | Description |
|---|----------|---|
|  | M100335 | <u>Condenser Tube (All Models)</u> |
|  | M100336 | <u>Arm Valve Assembly</u> |
|  | M100338 | <u>Reservoir Cover Assembly</u> |
|  | M100339 | <u>Power Cord without Connectors</u> |
|  | M100343 | <u>Reservoir Assembly</u> <u>OCM_Serial # 16526 & Above)</u> |



Main Valve Assy. (all Models)

M100345

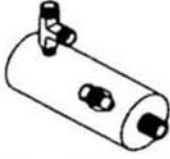

Seat & Air Valve housing assy.

M100346

(OCR- Serial #15050 and Above) & (C



Door Gasket (OCR & OCR+)

M100347



Drain Cap Insert

M100348

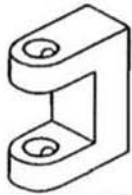

Door Hinge Block (OCR)

M100349

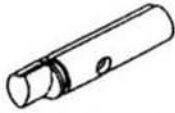

Door Cam (OCR)

M100350









Overheat Shield (OCR & OCR+)



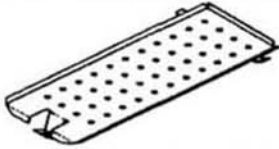

M100351

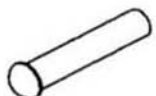

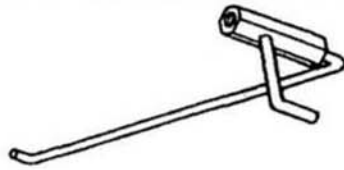

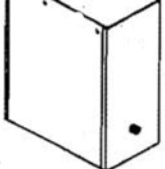

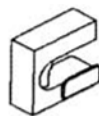
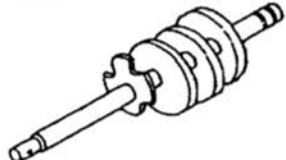
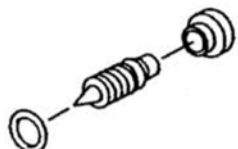
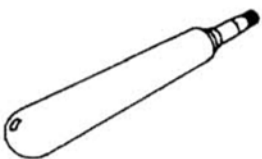
Drain Tube Cap (all Models)



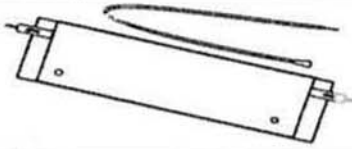

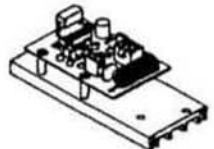

M100352

| | Part No. | Description |
|---|----------|---|
|  | M100354 | <u>Drain Tube (OCR-Serial#5671 & (OCR)</u> |
|  | M100355 | <u>Air Valve Tube/Main Valve (OCR)</u> |
|  | M100356 | <u>Tray Rest & Support Assembly</u> |
|  | M100357 | <u>Power Cord With Connectors</u> |
|  | M100358 | <u>Hinge Pin & Cap (OCR)</u> |
|  | M100359 | <u>Fool Kit- 4 ea. (All Models)</u> |
|  | M100360 | <u>Filter & Tube assembly (All Models)</u> |
|  | M100361 | <u>Thermometer Housing Assy.</u> |

| | Part No. | Description |
|---|----------|---|
|  | M100362 | <u>Reservoir Assembly</u> <u>(OCR- Serial# 15050 & Above)</u> <u>& (OCR+)</u> |
|  | M100363 | <u>Reservoir Top</u> <u>(OCR- Serial# 15050 & Above)</u> <u>& (OCR+)</u> |
|  | M100364 | <u>Catch Block Assembly (OCR)</u> |
|  | M100365 | <u>Cam Shaft (OCM & OCR)</u> <u>(Serial# 41588 & Above)</u> |
|  | M100366 | <u>Bellow & Cap Assy (All Models)</u> |
|  | M100367 | <u>Door Handle (OCM & OCR)</u> |
|  | M100368 | <u>Timer & Valve Knob (All Models)</u> |
|  | M100369 | <u>Thermostat Knob</u> |

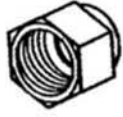
| | Part No. | Description |
|---|----------|--|
|  | M100371 | <u>heating Element-120v</u> <u>(OCR & OCR+)</u> |
|  | M100373 | <u>Heating Elements-240v</u> <u>(OCR & OCR+)</u> |
|  | M100374 | <u>Main Valve repair kit (OCM & OCR)</u> |
|  | M100375 | <u>Terminal Bushing (OCM & OCR)</u> |
|  | M100376 | <u>Solid State Controller</u> |
|  | M100378 | <u>Thermistor Assembly (All Models)</u> |
|  | M100379 | <u>Wiring Harness</u> <u>(OCM- Serial# 69564 & Above)</u> |

| | Part No. | Description |
|---|----------|--|
|  | M100380 | <u>Wiring Harness (OCR)</u> |
|  | M100381 | <u>PCB Adapter Kit- 240V</u> |
|  | M100382 | <u>Bolt (OCR)</u> |
|  | M100383 | <u>Casing Screw (All Models)</u> |
|  | M100384 | <u>Instruments Tray- Large (OCR & OCR+)</u> |
|  | M100385 | <u>Instruments Tray- Small (OCR & OCR+)</u> |
|  | M100386 | <u>Air Valve Nut</u> |
|  | M100387 | <u>Band (OCR & OCR+)</u> |
|  | M100388 | <u>Fill Chamber Tube (All Models)</u> |

| | Part No. | Description |
|---|----------|--|
|  | M100389 | <u>Fill Line Filter (All Models)</u> |
|  | M100390 | <u>Compression Nut (All Models)</u> |
|  | M100392 | <u>Compression Sleeve (All Models)</u> |
|  | M100403 | <u>Condenser Tube Nut (All Models)</u> |
|  | M100393 | <u>Compression Sleeve (All Models)</u> |
|  | M100395 | <u>Omni-cleaner (16 oz/12 Per case)</u> |
|  | M100396 | <u>Screw (All Models)</u> |
|  | M100397 | <u>Pressure Gauge (OCR & OCR+)</u> |

| | Part No. | Description |
|---|----------|--|
|  | M100398 | <p align="center"><u>Frame Support Kit (OCR)</u></p> |
|  | M100402 | <p align="center"><u>Temperature Gauge (All Models)</u></p> |
|  | M100861 | <p align="center">Wire Harness For Ocr sterilizer</p> |
|  | M100862 | <p align="center">Door Gasket</p> <p align="right">OCR</p> |



**Your
Sterilizer
Experts**

**MAIL-IN
STERILIZER
MONITORING
SERVICE**



Order No.

EMS-012

Retail Price

\$125.00

12 Tests

Order No.

EMS-052

Retail Price

\$235.00

52 Tests

Sterilization records via FDA registered facility.

Two year "shelf-life" from the date of manufacture.

Every process (Steam, Chemical vapor, EO and Dry heat).

Recommended and used by most sterilizer manufacturers.

ImmEDIATE and confidential phone call in case of failure.

Largest sterilizer testing Laboratory in the United States.

Economically priced from your **Full Service Dealer!**



Your Sterilizer Experts

Manufacturing – Distribution – Maintenance- Guaranteed!

Alfa Medical
265 Post Avenue
Westbury NY 11590

1-800-762-1586
516-280-7822
516-977-7434 fax
Web site www.sterilizers.com

Email Email@sterilizers.com

To whom it may concern:

Subject: FDA 510K approval for sterilizers manufactured prior to May 28th, 1976

1. There is no need for 510K FDA approvals for "Pelton & Crane OCM & OCR". This is because according to the FDA rulings, these sterilizers were manufactured and commercially distributed before May 28, 1976 and didn't require Pre Market Approvals.
2. The FDA clause regarding this can be found in **Subpart E- Premarket Notification Procedures Section 807.85 Exemption from pre market notification in Section 1**
3. One of the ways to prove that the sterilizer was manufactured and distributed before May 28th, 1976, is to show catalog pages, promotional material with dates prior to May 28th, 1976
4. Attached you will find two documents:
 - a. The FDA documentation explaining that point 2.
 - b. Catalog of this sterilizer with dates prior to May 28th, 1976

Please call if you have a need for further help,

Alfa Medical
Customer Service.

OMNI-CLAVE

MODELS — OCM
OCR

SERVICE MANUAL

When ordering parts please specify:

PART NUMBER
PART NAME
QUANTITY
SERIAL NUMBER

TABLE OF CONTENTS

1. Trouble Shooting Procedures
2. Function of Component Parts
3. How To—
4. Operating Instructions
5. Wiring and Piping Diagrams
6. Parts List

TROUBLE SHOOTING INDEX

CONTROL OF STERILIZING PRESSURE

- A. Erratic control of pressure.
- B. Will not build up to sterilizing pressure.
- C. Sterilizing time less than one hour.
- D. Pressure builds up too slowly.

DOOR

- A. Gasket leaks.
- B. Door bolt difficult to slide into catch.
- C. Door bolt difficult to slide in door.

THERMOMETER

- A. Thermometer reads low.
- B. Thermometer reads high.

CONTROL KNOB

- A. Control knob does not position positively.

PILOT LIGHTS

- A. Bulbs slow to light.

TIMER

- A. Bell will not ring.
- B. Timer does not time accurately.

RESERVOIR

- A. Water bubbles out of reservoir with control at VENT.

DRY HEAT

- A. Steam-dry safety interlock button cannot be depressed with control in VENT.
- B. Dry-heat temperature will not reach 340° F.

SPECIAL

- A. Function or power switch either shorted in STERILIZE or VENT position.
- B. Safety Valve leaks.
- C. Circuit breaker on models after Serial No. 16526 for OCM and Serial No. 5886 for OCR kicks out.

Pelton & Crane COMPANY

act, or because the Commissioner has found, under section 510(g)(4) of the act, that such registration is not necessary for the protection of the public health:

(a) A manufacturer of raw materials or components to be used in the manufacture or assembly of a device who would otherwise not be required to register under the provisions of this part.

(b) A manufacturer of devices to be used solely for veterinary purposes.

(c) A manufacturer of general purpose articles such as chemical reagents or laboratory equipment whose uses are generally known by persons trained in their use and which are not labeled or promoted for medical uses.

(d) Licensed practitioners, including physicians, dentists, and optometrists, who manufacture or otherwise alter devices solely for use in their practice.

(e) Pharmacies, surgical supply outlets, or other similar retail establishments making final delivery or sale to the ultimate user. This exemption also applies to a pharmacy or other similar retail establishment that purchases a device for subsequent distribution under its own name, e.g., a properly labeled health aid such as an elastic bandage or crutch, indicating "distributed by" or "manufactured for" followed by the name of the pharmacy.

(f) Persons who manufacture, prepare, propagate, compound, or process devices solely for use in research, teaching, or analysis and do not introduce such devices into commercial distribution.

(g) [Reserved]

(h) Carriers by reason of their receipt, carriage, holding or delivery of devices in the usual course of business as carriers.

(1) Persons who dispense devices to the ultimate consumer or whose major responsibility is to render a service necessary to provide the consumer (i.e., patient, physician, layman, etc.) with a device or the benefits to be derived from the use of a device; for example, a hearing aid dispenser, optician, clinical laboratory, assembler of diagnostic x-ray systems, and personnel from a hospital, clinic, dental laboratory, orthotic or prosthetic retail facility, whose primary responsibility to the ultimate consumer is to dispense or pro-

vide a service through the use of a previously manufactured device.

[42 FR 42526, Aug. 23, 1977, as amended at 58 FR 46523, Sept. 1, 1993]

Subpart E—Premarket Notification Procedures

§ 807.81 When a premarket notification submission is required.

(a) Except as provided in paragraph (b) of this section, each person who is required to register his establishment pursuant to § 807.20 must submit a premarket notification submission to the Food and Drug Administration at least 90 days before he proposes to begin the introduction or delivery for introduction into interstate commerce for commercial distribution of a device intended for human use which meets any of the following criteria:

(1) The device is being introduced into commercial distribution for the first time; that is, the device is not of the same type as, or is not substantially equivalent to, (i) a device in commercial distribution before May 28, 1976, or (ii) a device introduced for commercial distribution after May 28, 1976, that has subsequently been reclassified into class I or II.

(2) The device is being introduced into commercial distribution for the first time by a person required to register, whether or not the device meets the criteria in paragraph (a)(1) of this section.

(3) The device is one that the person currently has in commercial distribution or is reintroducing into commercial distribution, but that is about to be significantly changed or modified in design, components, method of manufacture, or intended use. The following constitute significant changes or modifications that require a premarket notification:

(i) A change or modification in the device that could significantly affect the safety or effectiveness of the device, e.g., a significant change or modification in design, material, chemical composition, energy source, or manufacturing process.

(1) A major change or modification in the intended use of the device.

(b) A premarket notification under this subpart is not required for a device

for which a premarket approval application under section 515 of the act, or for which a petition to reclassify under section 513(f)(2) of the act, is pending before the Food and Drug Administration.

(c) In addition to complying with the requirements of this part, owners or operators of device establishments that manufacture radiation-emitting electronic products, as defined in § 1000.3 of this chapter, shall comply with the reporting requirements of Part 1002 of this chapter.

§ 807.85 Exemption from premarket notification.

(a) A device is exempt from the premarket notification requirements of this subpart if the device intended for introduction into commercial distribution is not generally available in finished form for purchase and is not offered through labeling or advertising by the manufacturer, importer, or distributor thereof for commercial distribution, and the device meets one of the following conditions:

(1) It is intended for use by a patient named in the order of the physician or dentist (or other specially qualified person); or

(2) It is intended solely for use by a physician or dentist (or other specially qualified person) and is not generally available to, or generally used by, other physicians or dentists (or other specially qualified persons).

(b) A distributor who places a device into commercial distribution for the first time under his own name and a repackager who places his own name on a device and does not change any other labeling or otherwise affect the device shall be exempted from the premarket notification requirements of this subpart if:

(1) The device was in commercial distribution before May 28, 1976; or

(2) A premarket notification submission was filed by another person.

§ 807.87 Information required in a premarket notification submission.

Each premarket notification submission shall contain the following information:

(a) The device name, including both the trade or proprietary name and the

common or usual name or classification name of the device.

(b) The establishment registration number, if applicable, of the owner or operator submitting the premarket notification submission.

(c) The class in which the device has been put under section 513 of the act and, if known, its appropriate panel; or, if the owner or operator determines that the device has not been classified under such section, a statement of that determination and the basis for the person's determination that the device is not so classified.

(d) Action taken by the person required to register to comply with the requirements of the act under section 514 for performance standards.

(e) Proposed labels, labeling, and advertisements sufficient to describe the device, its intended use, and the directions for its use. Where applicable, photographs or engineering drawings should be supplied.

(f) A statement indicating the device is similar to and/or different from other products of comparable type in commercial distribution, accompanied by data to support the statement. This information may include an identification of similar products, materials, design considerations, energy expected to be used or delivered by the device, and a description of the operational principles of the device.

(g) Where a person required to register intends to introduce into commercial distribution a device that has undergone a significant change or modification that could significantly affect the safety or effectiveness of the device, or the device is to be marketed for a new or different indication for use, the premarket notification submission must include appropriate supporting data to show that the manufacturer has considered what consequences and effects the change or modification or new use might have on the safety and effectiveness of the device.

(h) A 510(k) summary as described in § 807.92 or a 510(k) statement as described in § 807.93.

(i) For submissions claiming substantial equivalence to a device which has been classified into class III under section 513(b) of the act:

516-280-7822



[Accessories](#)

[Alfa's Profile](#)

[Contact Us](#)

[Home](#)

[Parts](#)

[Support](#)

[Site Map](#)

[Testimonials](#)

[Trouble Shooting](#)

[Ultrasonic Cleaner](#)

[Used Sterilizers](#)

[What shall I get?](#)

[Create Account](#)

[Login](#)

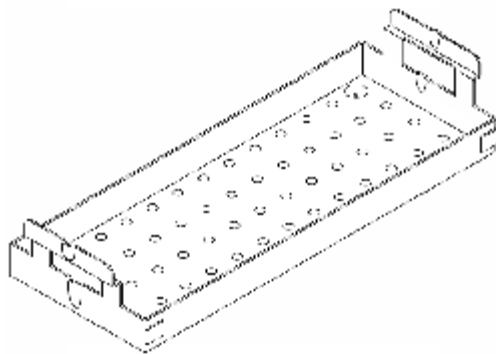

Item Number: M100305

Description: Pelton Crane OCM, Sentry Sterilizer - Small Tray

Your Price: \$81.55

Quantity needed:

516-280-7822



[Accessories](#)

[Alfa's Profile](#)

[Contact Us](#)

[Home](#)

[Parts](#)

[Support](#)

[Site Map](#)

[Testimonials](#)

[Trouble Shooting](#)

[Ultrasonic Cleaner](#)

[Used Sterilizers](#)

[What shall I get?](#)

[Create Account](#)

[Login](#)

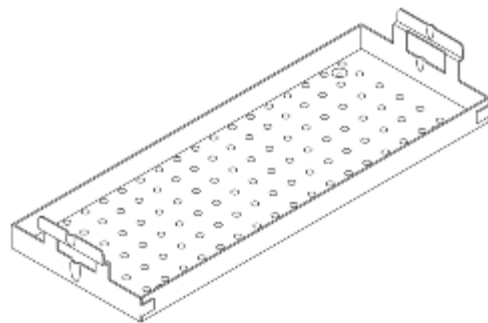

Item Number: M100385

Description: Delta 10 Delta Q10 OCR OCR+ Validator 10 - Tray Small

Your Price: \$126.32

Quantity needed:

516-280-7822



[Accessories](#)

[Alfa's Profile](#)

[Contact Us](#)

[Home](#)

[Parts](#)

[Support](#)

[Site Map](#)

[Testimonials](#)

[Trouble Shooting](#)

[Ultrasonic Cleaner](#)

[Used Sterilizers](#)

[What shall I get?](#)

[Create Account](#)

[Login](#)

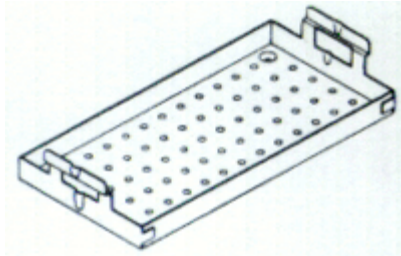

Item Number: M100306

Description: Large tray for Pelton Crane OCM Sterilizer

The OEM part number is 004141

Your Price: \$97.17

Quantity needed:

516-280-7822



[Accessories](#)

[Alfa's Profile](#)

[Contact Us](#)

[Home](#)

[Parts](#)

[Support](#)

[Site Map](#)

[Testimonials](#)

[Trouble Shooting](#)

[Ultrasonic Cleaner](#)

[Used Sterilizers](#)

[What shall I get?](#)

[Create Account](#)

[Login](#)

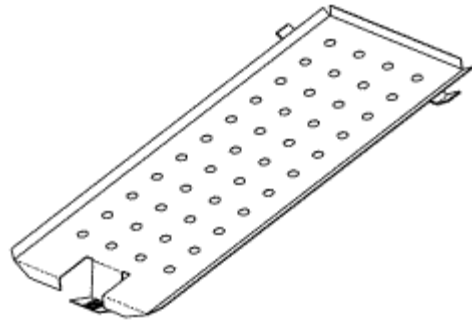

Item Number: M100337

Description: Pelton Crane OCM sterilizer - Tray Rest

Your Price: \$68.37

Quantity needed:

516-280-7822



[Accessories](#)

[Alfa's Profile](#)

[Contact Us](#)

[Home](#)

[Parts](#)

[Support](#)

[Site Map](#)

[Testimonials](#)

[Trouble Shooting](#)

[Ultrasonic Cleaner](#)

[Used Sterilizers](#)

[What shall I get?](#)

[Create Account](#)

[Login](#)

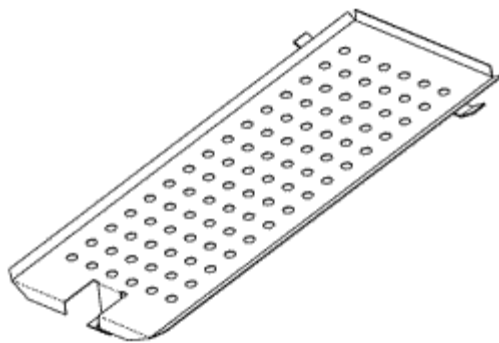

Item Number: M100356

Description: Pelton Crane OCR Sterilizer Tray Rest and Support assembly

Your Price: \$83.73

Quantity needed: